

UNITED STATES PUBLIC SECTION CORNER CERTIFICATION  
AND LAND CORNER SURVEY  
SECTION 3 T-86N R-2W

MADE FOR  
IOWA DEPARTMENT OF TRANSPORTATION FOR THE PURPOSE OF  
RIGHT OF WAY DESCRIPTIONS ON PRIMARY ROAD No. U.S. 151

MADE BY  
MICHAEL R. FAGLE R.L.S. No. 8505  
JONES COUNTY, IOWA NHS-151-3(84)--19-57  
APRIL 1998 THRU OCTOBER 1998

ALL DISTANCES WERE CAREFULLY MEASURED AND MAY NOT AGREE WITH ROAD SURVEY STATIONING

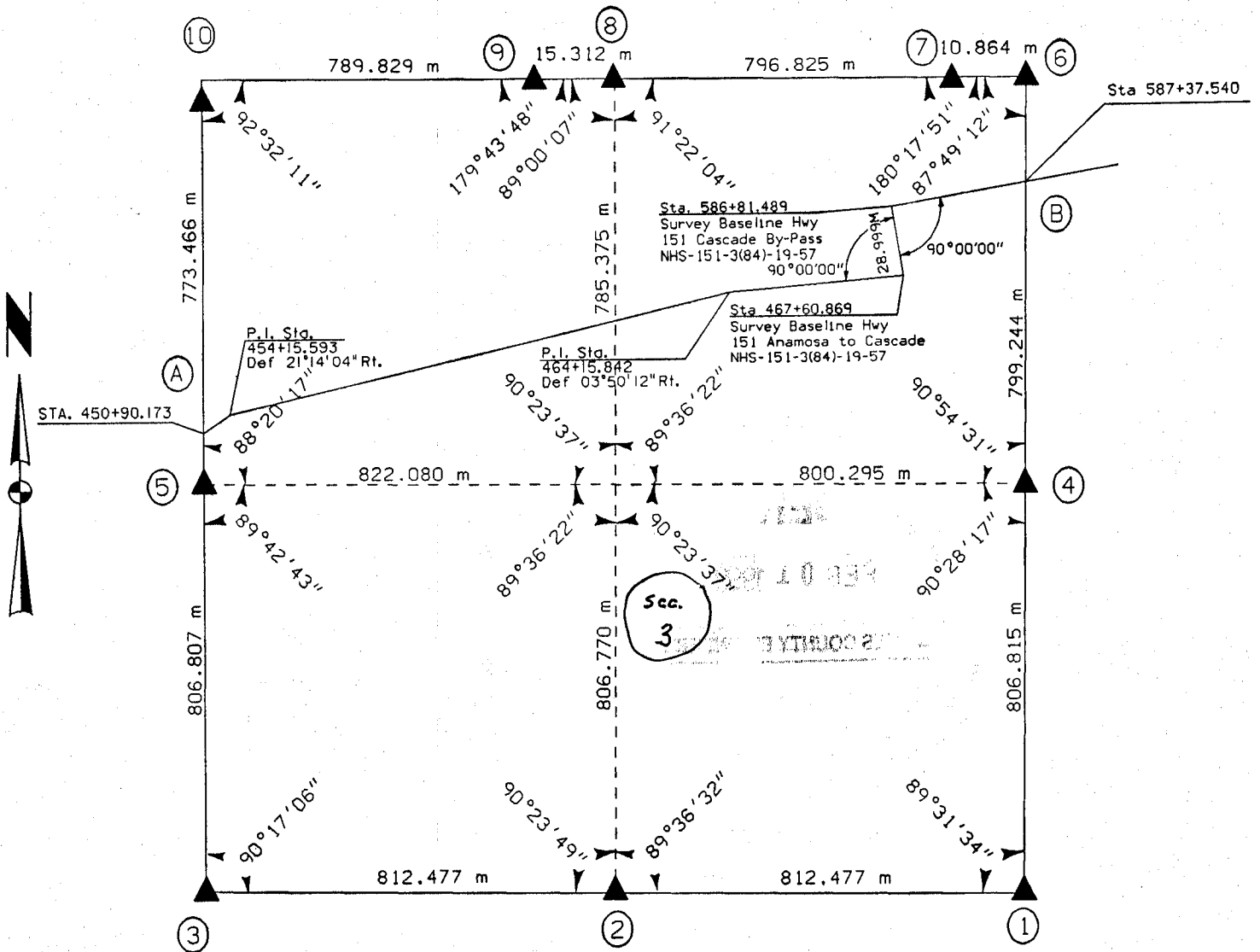

	I hereby certify that this Land Surveying document was prepared by me or under my direct personal supervision and that I am a duly Licensed Land Surveyor under the laws of the State of Iowa.
	Michael R Fagle 1-21-99 MICHAEL R. FAGLE Date
	License number 8505 My license renewal date is December 31,2000
	Pages or sheets covered by this seal: TWO (2)

**METRIC**

UNITED STATES PUBLIC SECTION CORNER CERTIFICATION  
AND LAND CORNER SURVEY  
SECTION 3 T-86N R-2W

1-21-99

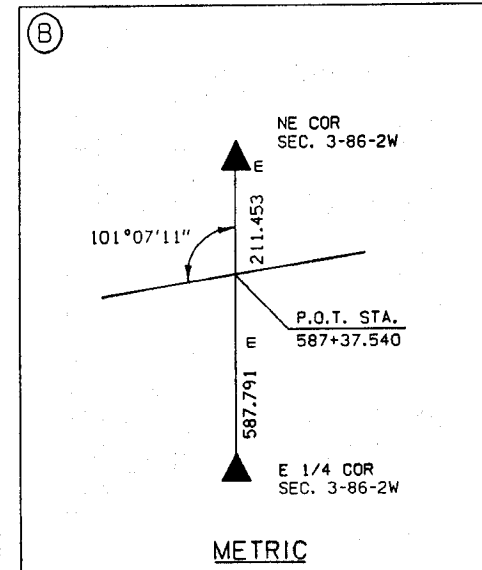
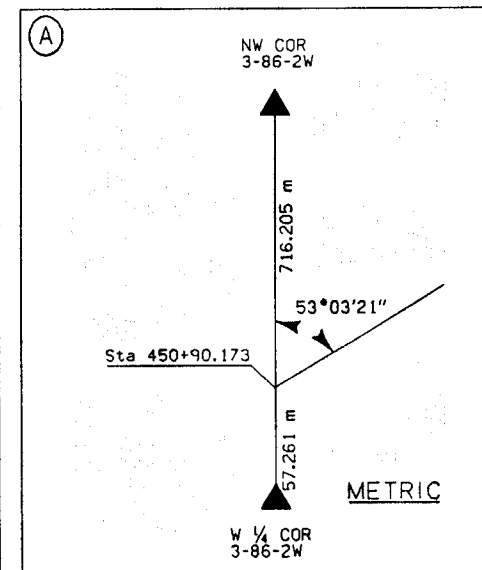
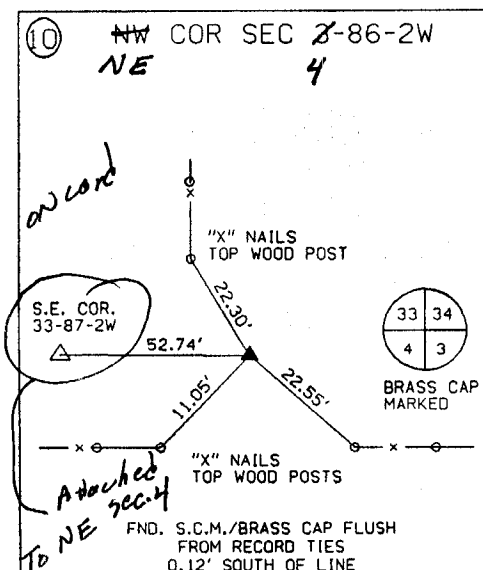
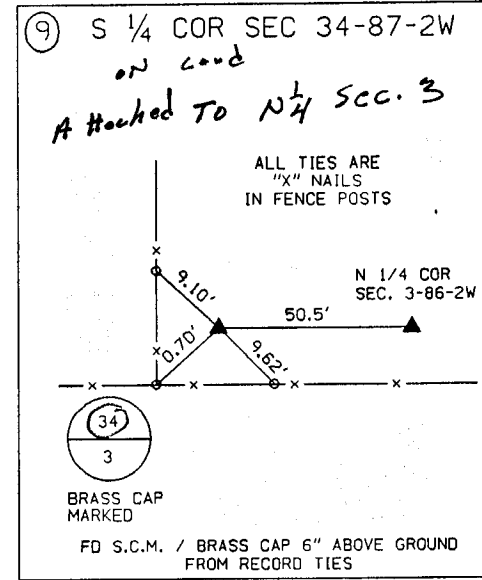
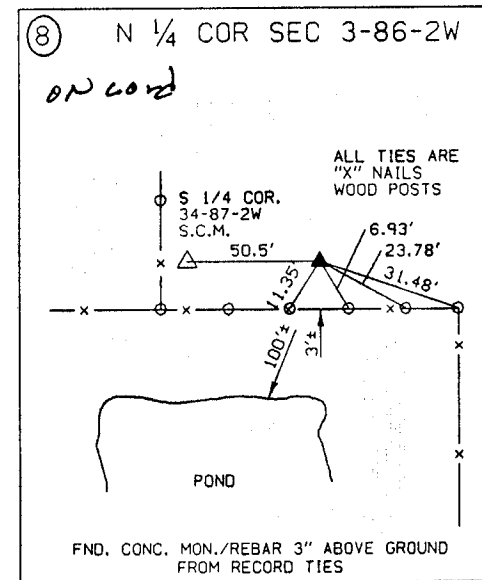
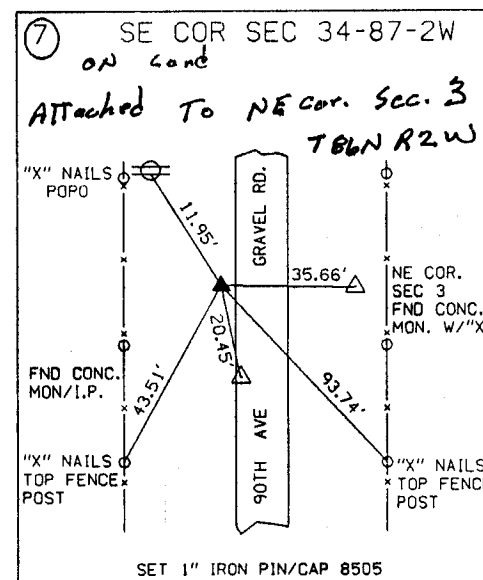
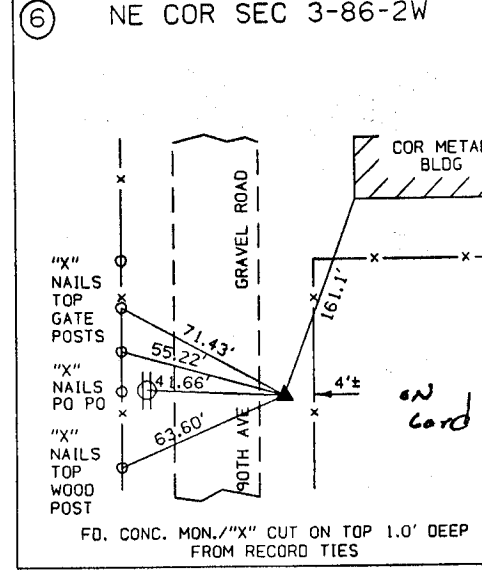
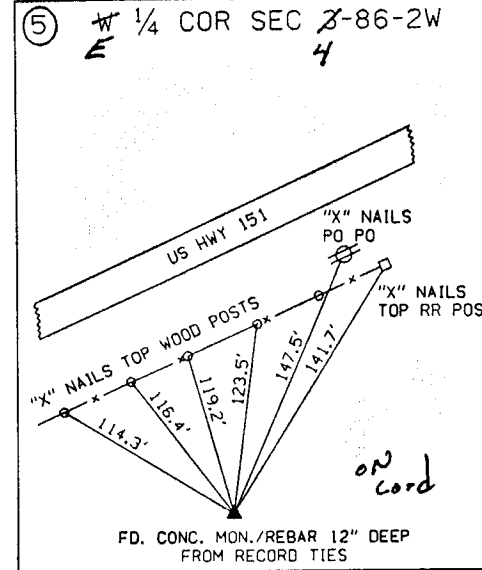
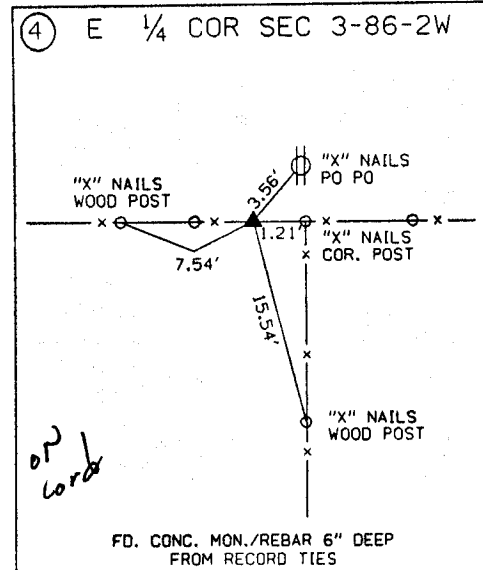
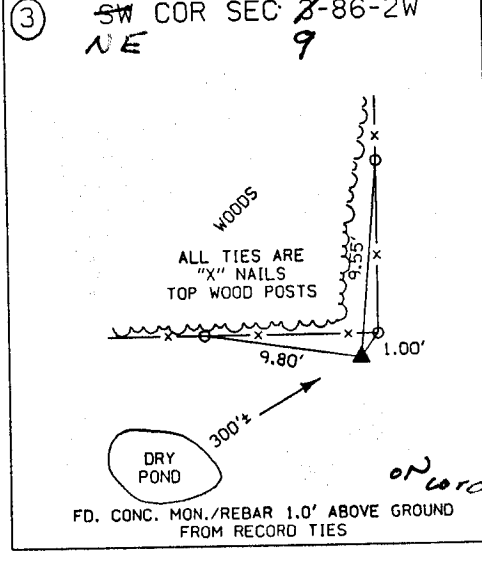
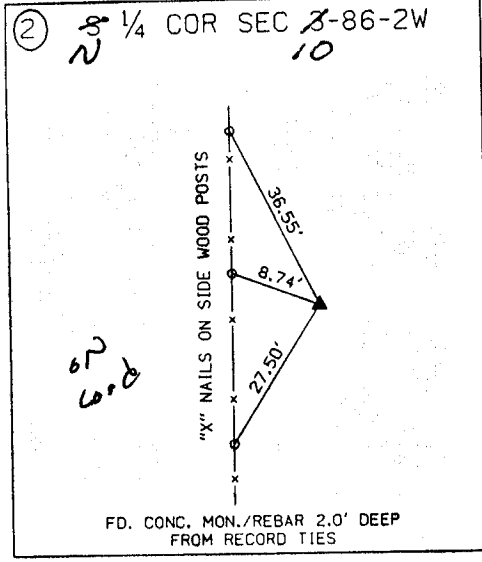
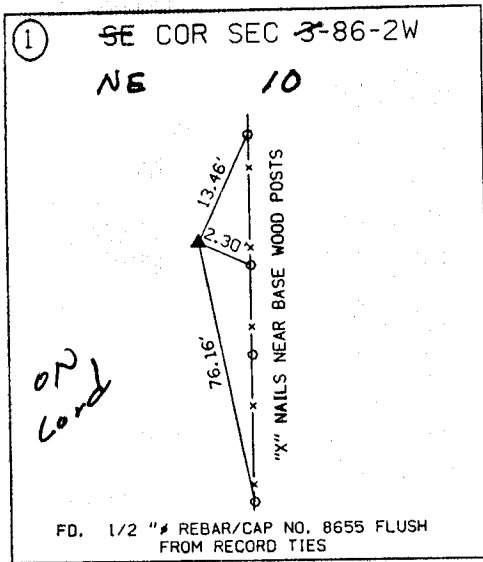

ALL TIES ARE ENGLISH UNLESS OTHERWISE NOTED

UNITED STATES PUBLIC SECTION CORNER CERTIFICATION  
AND LAND CORNER SURVEY

SECTION 2 T-86N R-2W

MADE FOR

IOWA DEPARTMENT OF TRANSPORTATION FOR THE PURPOSE OF  
RIGHT OF WAY DESCRIPTIONS ON PRIMARY ROAD No. U.S. 151

MADE BY

MICHAEL R. FAGLE R.L.S. No. 8505  
JONES COUNTY, IOWA NHS-151-3(84)--19-57  
FEBURARY 2, 1996 THRU JANUARY 15, 1997

ALL DISTANCES WERE CAREFULLY MEASURED AND MAY NOT AGREE WITH ROAD SURVEY STATIONING

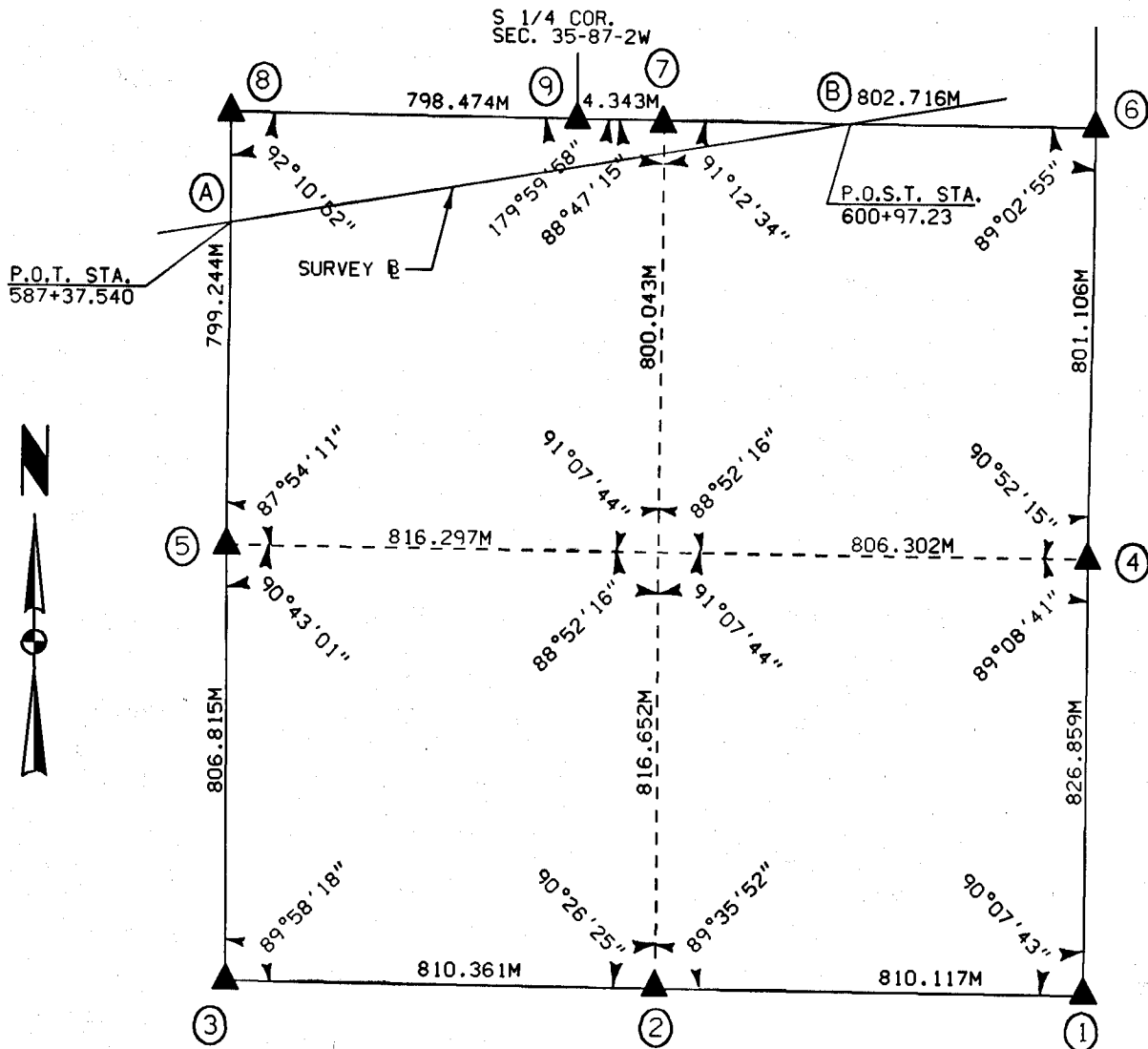

	I hereby certify that this Land Surveying document was prepared by me or under my direct personal supervision and that I am a duly Licensed Land Surveyor under the laws of the State of Iowa.
	<i>Michael R Fagle</i> 7-24-98 MICHAEL R. FAGLE Date
	License number 8505
	My license renewal date is December 31, 1998
	Pages or sheets covered by this seal: _____ _____

7-24-98

UNITED STATES PUBLIC SECTION CORNER CERTIFICATION  
AND LAND CORNER SURVEY  
SECTION 2 T-86N R-2W

MADE FOR  
IOWA DEPARTMENT OF TRANSPORTATION FOR THE PURPOSE OF  
RIGHT OF WAY DESCRIPTIONS ON PRIMARY ROAD No. U.S. 151

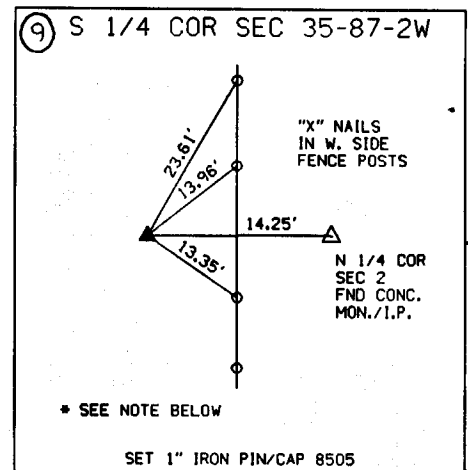
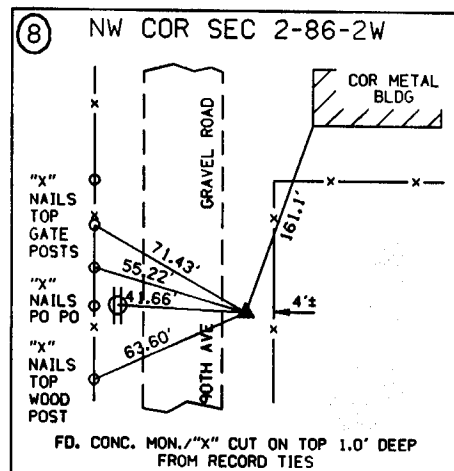
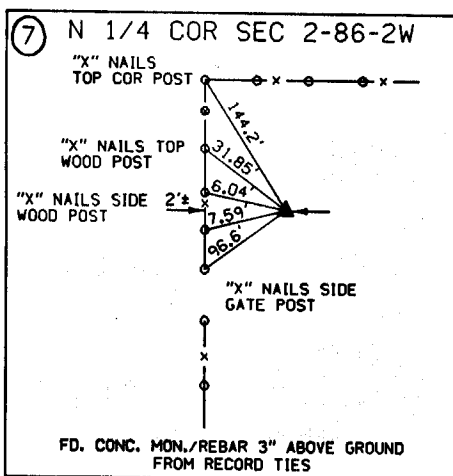
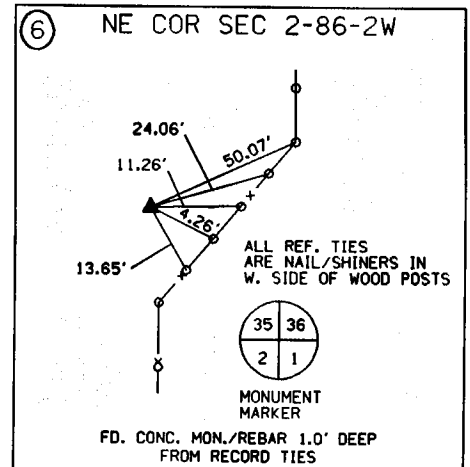
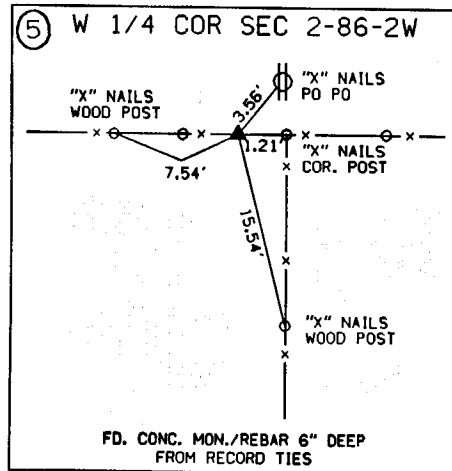
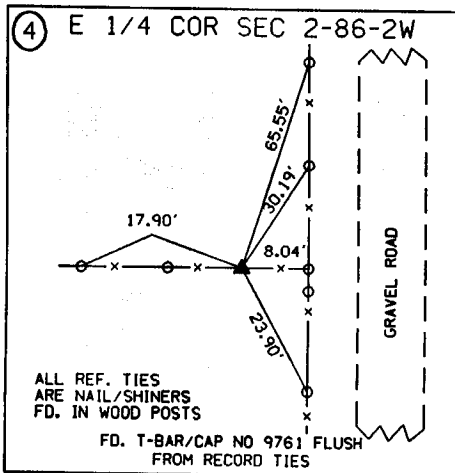
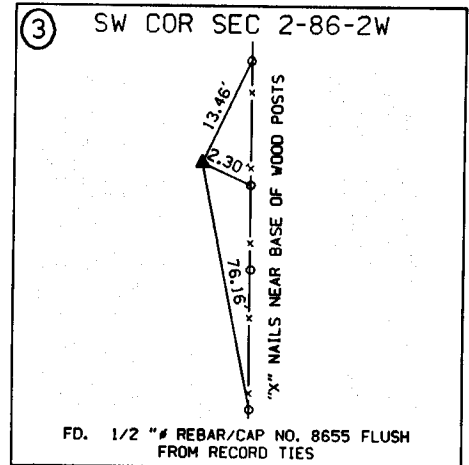
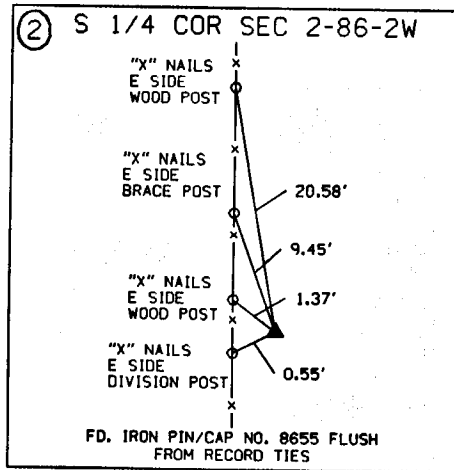
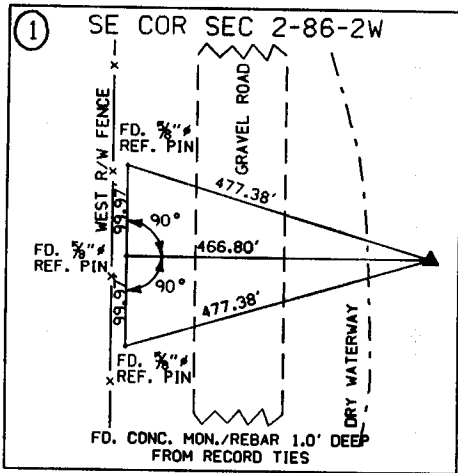

NOTES :

SET THE S 1/4 COR. OF SEC. 35-87-2W 14.25 FEET WEST OF THE N 1/4 CORNER OF SEC. 2-86-2W. POSITION OF CORNER WAS DETERMINED FROM CHAINING NOTES. USING PROPORTION DISTANCE BETWEEN SW COR. SEC. 35-87-2W AND A POINT 6.60 FEET EAST OF NE COR. OF SEC. 2-86-2W

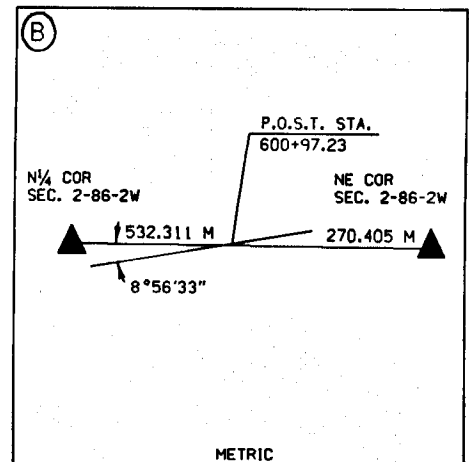
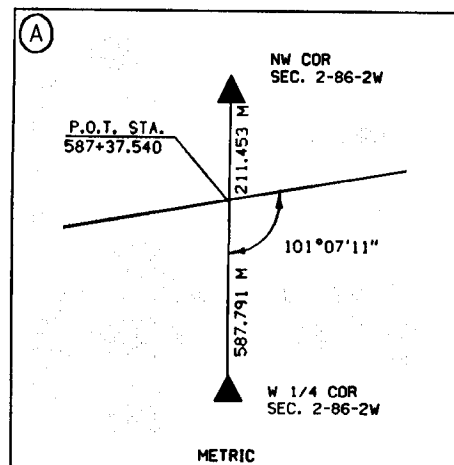

REVISED 7-24-98

ALL TIES ARE ENGLISH UNLESS OTHERWISE NOTED

SHEET 2 OF 2

98 99 0536

FILED  
RECORDERS OFFICE  
JONES COUNTY IOWA

98 AUG 12 AM 10: 14

LINDA J. BENDIXEN  
RECORDER 16.00 pd

Rust Environment and Infrastructure - 501 Sycamore Street - Waterloo, Iowa - 1-319-232-6531

AFFIDAVIT FOR CORRECTION TO SECTION CORNER CERTIFICATE

DATE: JULY 29, 1998

AFFIDAVIT FOR CORRECTIONS MADE TO SECTION CORNER CERTIFICATION FILE IN THE JONES COUNTY RECORDER'S OFFICE.

THE TIES OF THE SOUTH QUARTER CORNER OF SECTION 35 TOWNSHIP 87 NORTH RANGE 2 WEST OF THE 5TH P.M. WAS CHANGED.

MICHAEL R. FAGLE  
L.S. NO. 8505

RECEIVED

AUG 14 1998

JONES COUNTY ENGINEER

UNITED STATES PUBLIC SECTION CORNER CERTIFICATION  
AND LAND CORNER SURVEY

SECTION 3 T-86N R-2W

MADE FOR

IOWA DEPARTMENT OF TRANSPORTATION FOR THE PURPOSE OF  
RIGHT OF WAY DESCRIPTIONS ON PRIMARY ROAD No. U.S. 151

MADE BY

MICHAEL R. FAGLE R.L.S. No. 8505  
JONES COUNTY, IOWA NHS-151-3(84)--19-57  
FEBURARY 2, 1996 THRU JANUARY 15, 1997

ALL DISTANCES WERE CAREFULLY MEASURED AND MAY NOT AGREE WITH ROAD SURVEY STATIONING

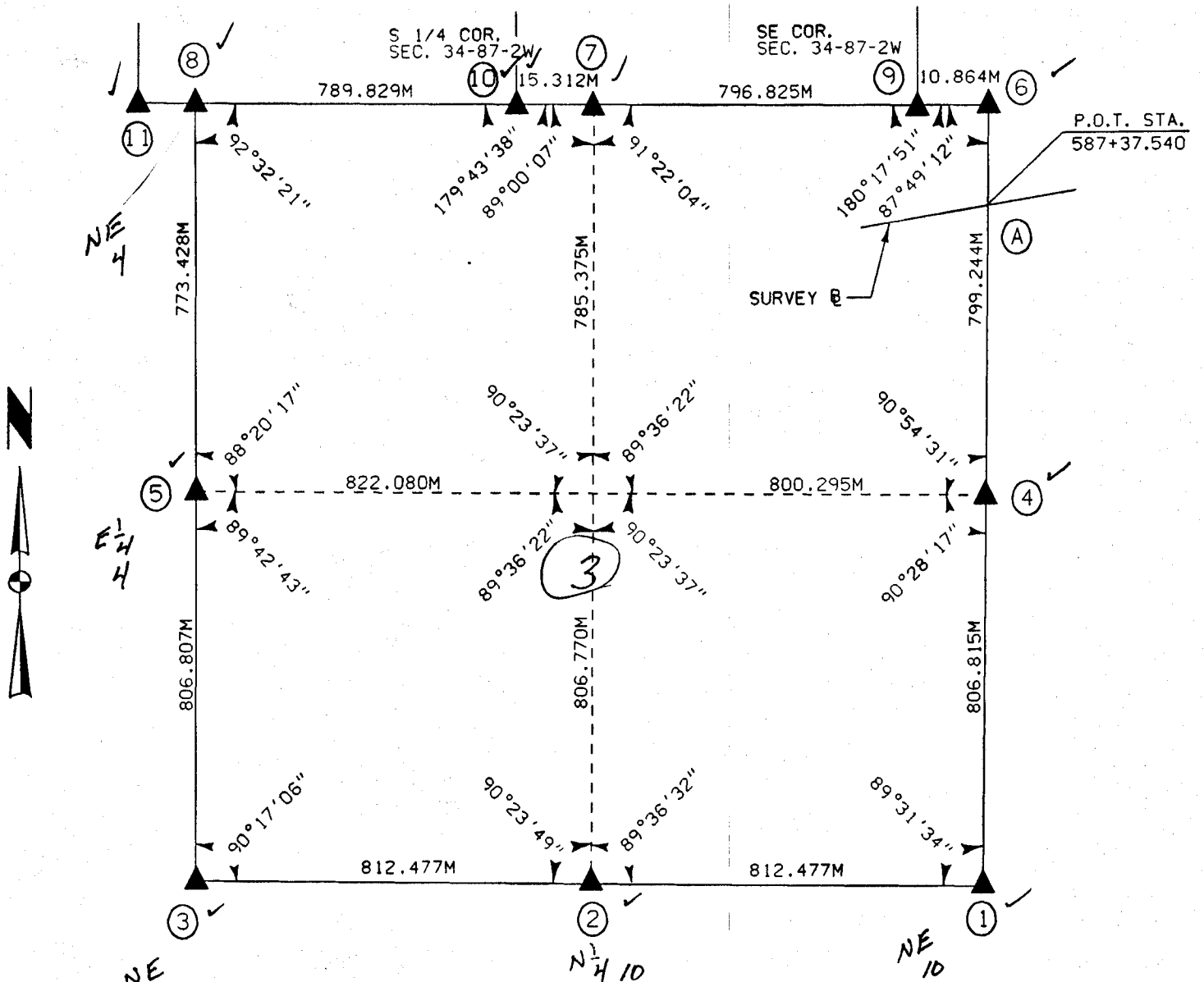

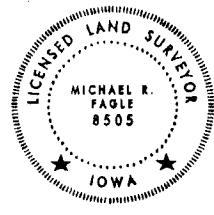
	I hereby certify that this Land Surveying document was prepared by me or under my direct personal supervision and that I am a duly Licensed Land Surveyor under the laws of the State of Iowa.
	<i>Michael R. Fagle</i> 1-10-97 MICHAEL R. FAGLE Date
	License number 8505
	My license renewal date is December 31, 1996
	Pages or sheets covered by this seal: _____ _____

UNITED STATES PUBLIC SECTION CORNER CERTIFICATION  
 AND LAND CORNER SURVEY  
 SECTION 3 T-86N R-2W

1-10-97

MADE FOR

IOWA DEPARTMENT OF TRANSPORTATION FOR THE PURPOSE OF  
 RIGHT OF WAY DESCRIPTIONS ON PRIMARY ROAD No. U.S. 151

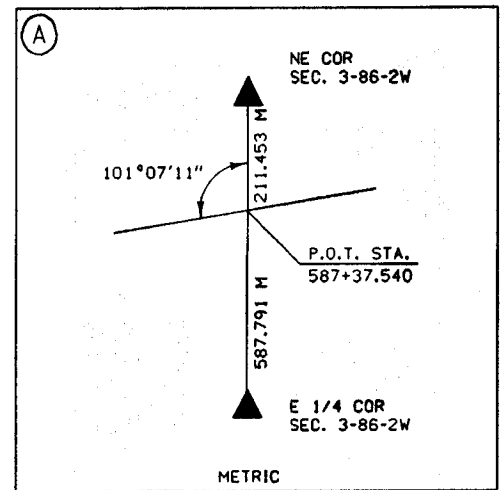
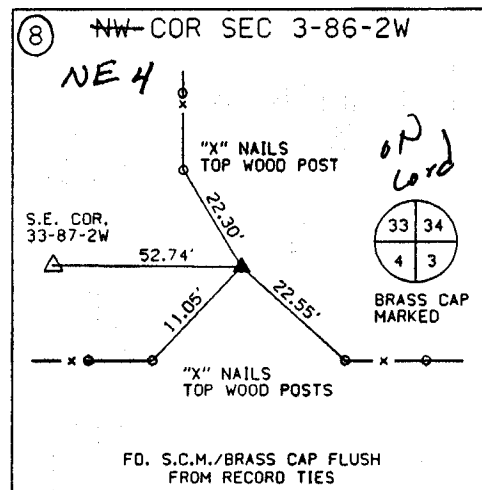
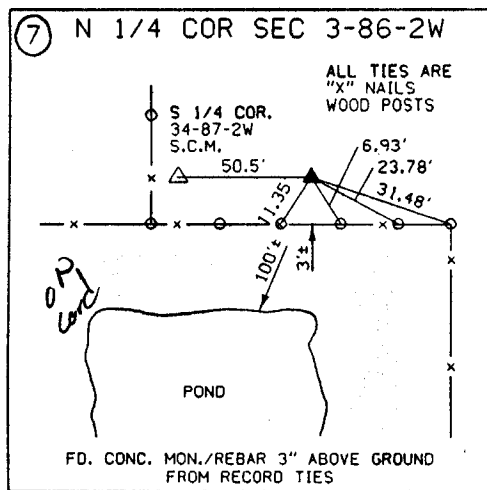
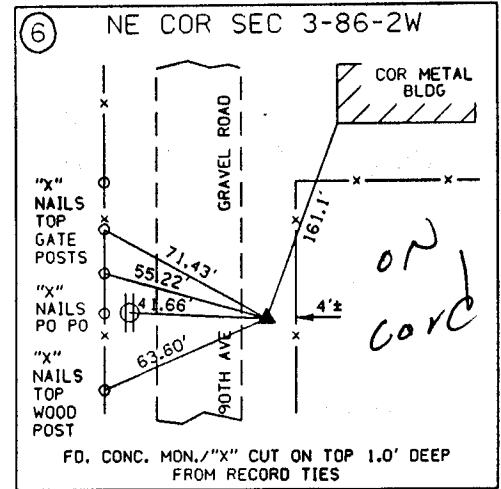
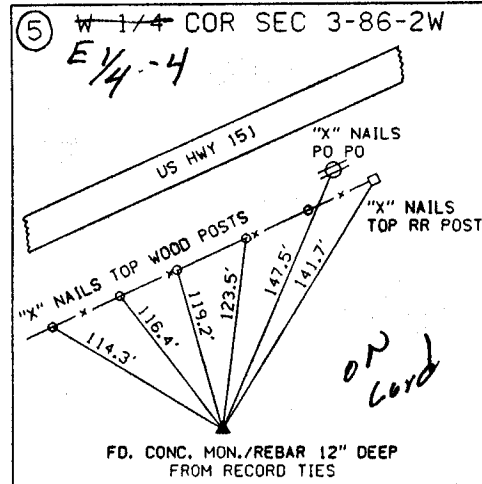
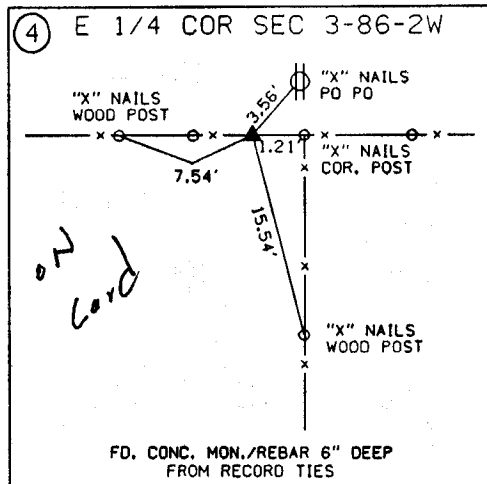
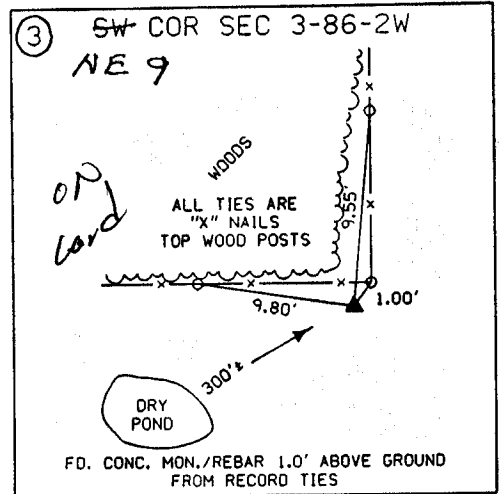
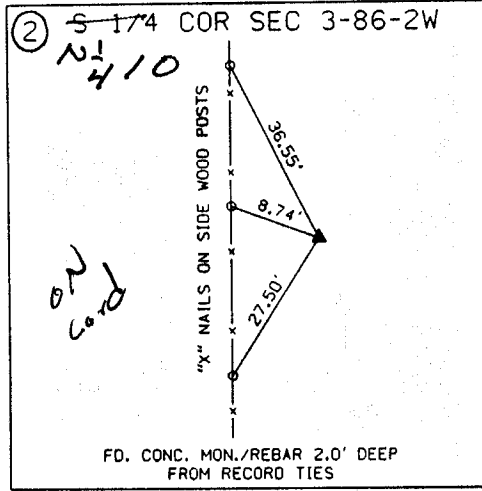
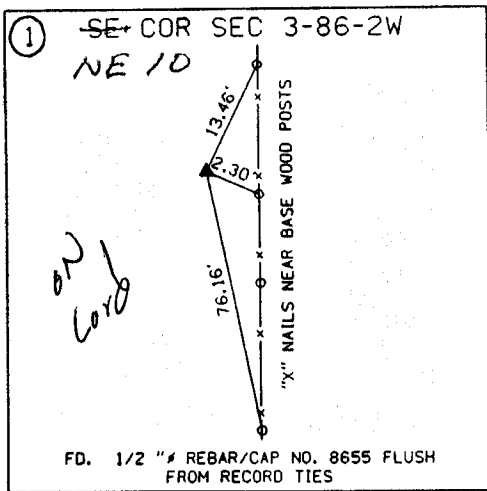

UNITED STATES PUBLIC SECTION CORNER CERTIFICATION  
AND LAND CORNER SURVEY

SECTION 34 T-87N R-2W

MADE FOR

1-10-97

IOWA DEPARTMENT OF TRANSPORTATION FOR THE PURPOSE OF  
RIGHT OF WAY DESCRIPTIONS ON PRIMARY ROAD No. U.S. 151

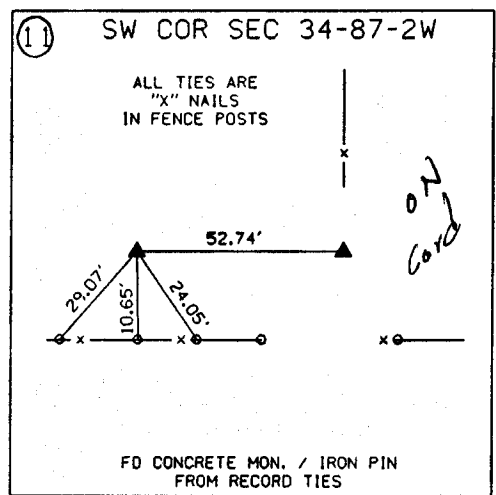
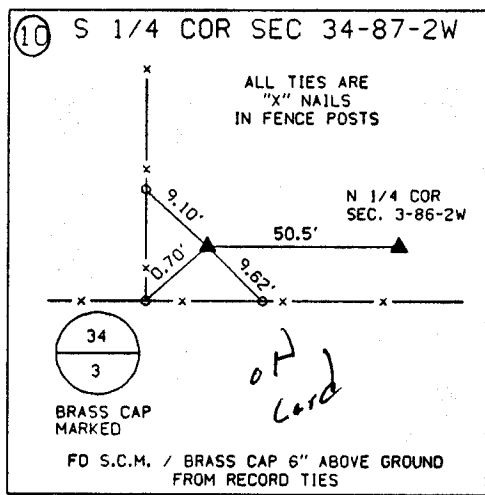
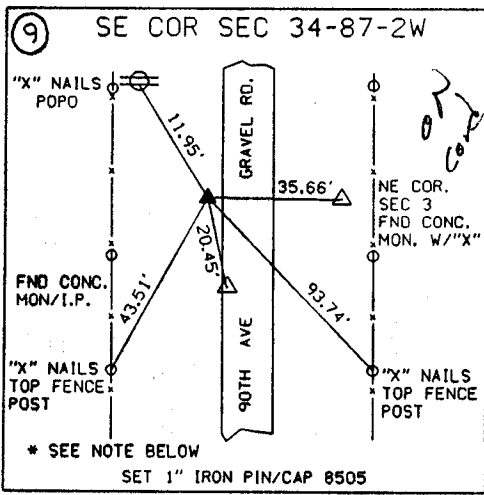

NOTES :

SET THE SE CORNER OF SEC. 34-87-2W  
35.66 FEET WEST OF THE NE COR. OF  
SEC. 3-86-2W FROM CHAINING NOTES.